

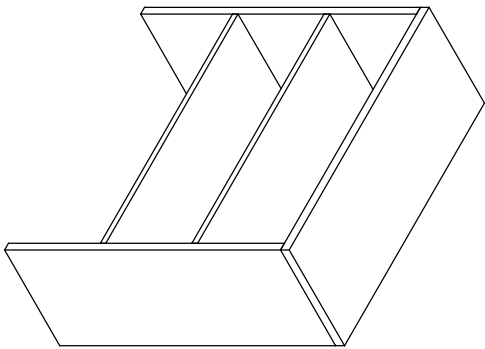







stilles™

CO390
36" OPEN HUTCH



Hardware List:

No.	Drawing	Description	Qty
A		Cam lock	13pcs
B		Cam-stud	13pcs
C		Grommet	13pcs
D		Dowel	16pcs
E		Shelf pin	8pcs
F		L-Bracket	2pcs
G		screw#4	8pcs

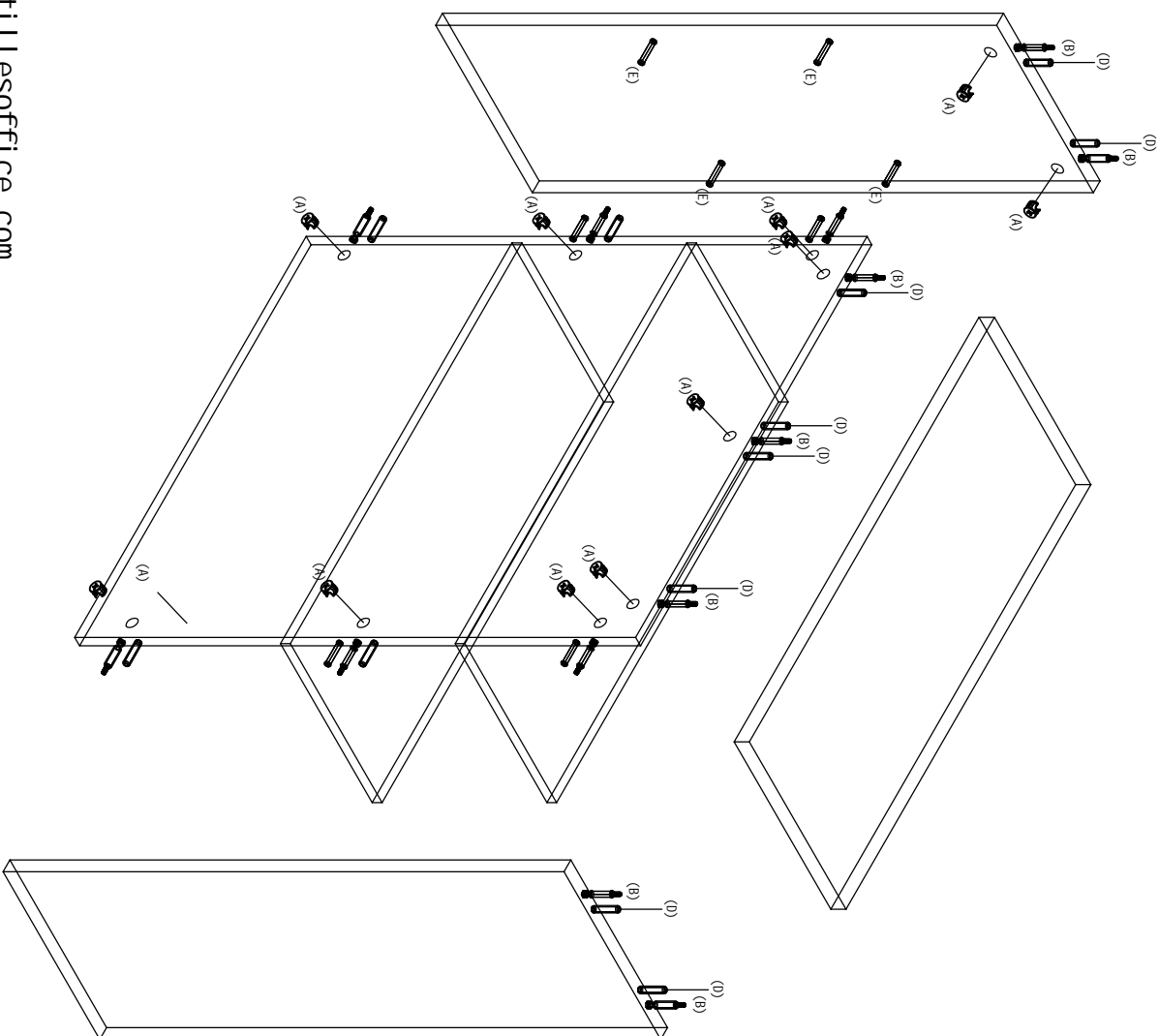

www.stillesoffice.com

Net:

Tel: 909930366

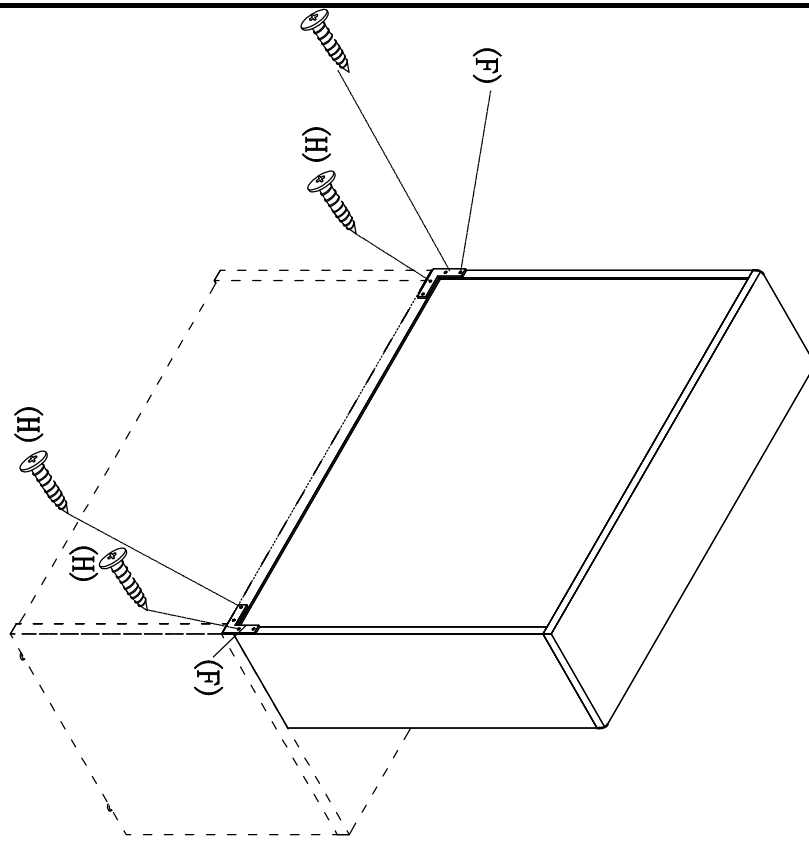

Step: 1

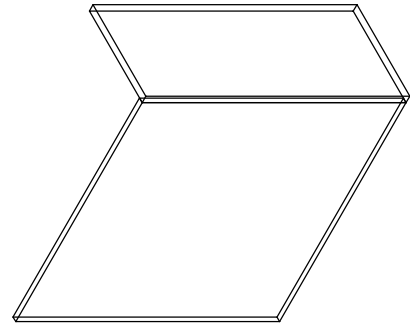

Step: 2

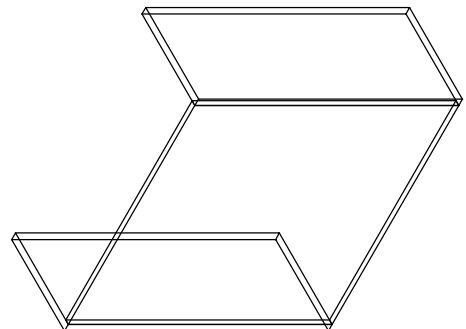

Step: 3

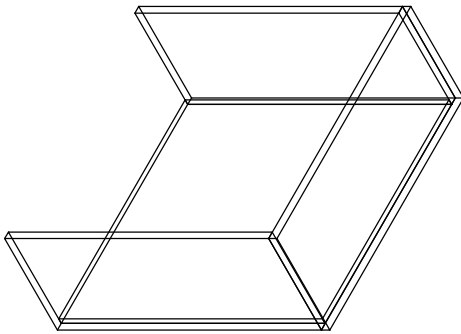

Step: 4

