

# stilles

---

QUALITY / DESIGN / VALUE

PRICE LIST

# Terms and Conditions

## 1. General Information

Stilles Office is a manufacturer and supplier of contract office grade case goods and furnishings. All products are created and exclusive to Stilles Office. Stilles Office reserves the right to change or amend all product descriptions, composition and pricing without advanced notice to current or past clients.

## 2. Confirmed Order

For product orders to be accepted each order must be in writing and sent via email, fax, overnight carrier or US mail. The order will be reviewed for accuracy and acknowledgement of that order will be sent to the entity which placed the order. If corrections need to be made to the order an acknowledgment will not be issued until the purchaser corrects and resubmits the order in writing.

As we ship in 48 hours acknowledgment needs to be sent when the order is approved. Stilles Office is committed to on time delivery and the delivery clock will start when the order acknowledgment is sent to purchaser. Stilles Office will make every effort to support a customer's delivery schedule.

## 3. Partial Shipments

Stilles Office will and can accommodate partial shipments; however, such split shipments must be submitted in writing and acknowledge prior to any and all shipping schedule changes. Partial shipments may affect the shipping charges applied to the order.

## 4. Specials

Stilles Office will make every effort to accommodate a customer's request for special orders. Such unique manufacturing requests will require a written request and will receive a written acknowledgement. All specials will require a 100% deposit and extended lead times may be apply. Special manufacturing orders are not cancellable or changeable.

## 5. Order Procedure

Stilles Office will make every attempt to process all orders. However, each submitted order will be subject to credit approval and must be placed by dealers or resellers which have been accredited by Stilles Office. Dealer or resellers who do not have a line of credit with Stilles Office will be required to submit the necessary credit application documents and references prior to any orders being processed.

At no time will verbal orders or verbal order changes be accepted. Stilles Office will not supply verbal order acknowledgments.

Stilles Office may require a deposit of no less than 50% of the net invoice to be received within 48 hours of the sending of the acknowledgement. If the deposit is not received within that time, the order can be cancelled and will need to be resubmitted. The deposit amount and/or time frame can be amended if it is agreed to by the Stilles General Manager or Vice President. Details of amendment must be documented in writing.

## 6. Order Cancellation

Stilles Office will accept order cancellations and will return deposit provided the cancellation is within 10 business days of the customer received acknowledgement. Cancellation must be received in writing and if it is not received within the prescribed 10 business days the order still can be cancelled, but the total deposit or percentage of the deposit will be forfeited. Once an order is shipped from the manufacturer the order is not cancellable.

## 7. Delivery

Stilles Office recognizes the shipping point to be Ontario, California. All shipping charges are based on standard delivery as defined as standard business hours Monday through Friday. Stilles Office reserves the right to select the carrier and route for all shipments. Orders requiring special delivery can possibly incur additional cost. Drop ship orders are defined as orders delivered to a location different than that of the dealer or reseller placing the order. All drop ship request will require advanced written confirmation from Stilles Office.

## 8. Freight Claims

All freight claims must be requested within 10 calendar days of receipt of product order. Claim must be submitted in writing, include digital photographs and be accompanied by the original bill of lading with damage documented on the said bill of lading. Stilles Office will administer all freight claims.

## 9. Concealed Product Damage

Concealed damage to the product is not anticipated; however, if such exists Stilles Office must be notified in writing including digital photographs within 10 calendar days of receipt of product. A Stilles Office claim form will be required and all accommodations will be made to replace the damaged product.

## 10. Returns

Stilles Office discourage returns; however, in the event it is necessary Stilles Office will issue a Return Merchandise Authorization (RMA) which must accompany each returned product. Stilles Office will require a restocking fee of 50% of original invoice cost. Freight to Stilles Office will be the responsibility of the dealer or reseller. Only non-assembled products are subject to return and credit will not be applied if the product returned is damaged.

## 11. Warranty

Stilles Office includes a warranty of 10 years, normal one shift wear and tear on all case goods and a three year warranty on all, normal one shift wear and tear, on all foam and fabric. Stilles Office reserves the right to hold discretion on any and all warranty claims. Of course, variations in natural materials is not considered a warranty issue. Nor is damage via transportation, product misuse or alterations made by user.

Stilles Office has limited liability in repair and replacement of product within warranty and each case will be reviewed individually.

## 12. Care & Maintenance

Although Stilles Office manufacturers products to the highest standards, it is incumbent on the user to treat the product with care. It is suggested that the product is dusted with a soft damp cloth, that objects are not dragged across the surface, that wet or hot objects are not placed directly on the product's surface. All mechanical parts such a drawer slides be lubricated regularly.

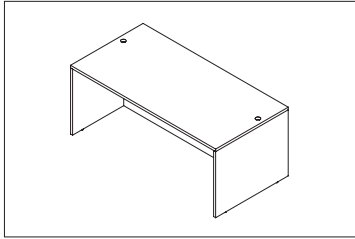

### Desk Shell

Item	W	D	H	Weight lbs.	Cubic Ft.	Cartons	List Price
CO900	71	35.5	29	162	6.40	1	\$485
CO902	66	30	29	136	5.50	1	\$390
CO903	60	30	29	128	4.60	1	\$365
CO907	48	30	29	110	4.50	1	\$348

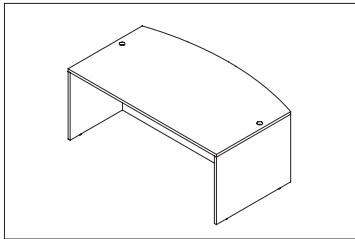

### Bow Front Desk Shell

Item	W	D	H	Weight lbs.	Cubic Ft.	Cartons	List Price
CO910	71	41	29	173	7.40	1	\$528

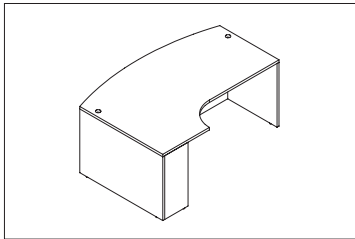

### Bow Front Desk w/Corner(L)

Item	W	D	H	Weight lbs.	Cubic Ft.	Cartons	List Price
CO917	71	48	29	184	8.40	1	\$595

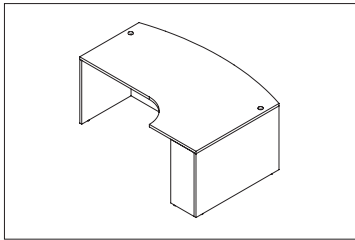

### Bow Front Desk w/Corner(R)

Item	W	D	H	Weight lbs.	Cubic Ft.	Cartons	List Price
CO916	71	48	29	184	8.40	1	\$595

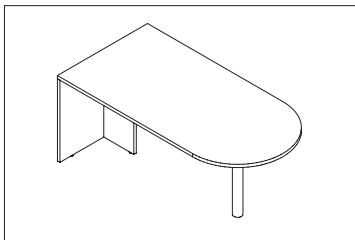

### Bullet Desk

Item	W	D	H	Weight lbs.	Cubic Ft.	Cartons	List Price
CO920	71	35.5	29	117	6.90	1	\$456

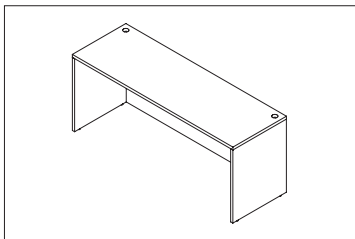

### Credenza Shell

Item	W	D	H	Weight lbs.	Cubic Ft.	Cartons	List Price
CO930	71	24	29	122	5.10	1	\$345
CO932	66	24	29	116	4.60	1	\$310

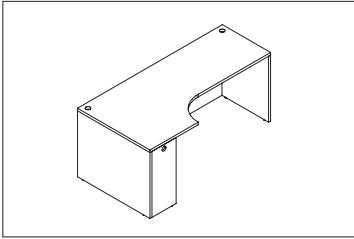

**Corner Credenza w/Corner(L)**

Item	W	D	H	Weight lbs.	Cubic Ft.	Cartons	List Price
CO937	71	35.5	29	149	6.40	1	\$480

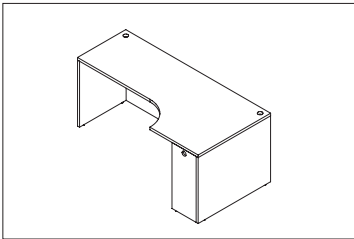

**Corner Credenza w/Corner(R)**

Item	W	D	H	Weight lbs.	Cubic Ft.	Cartons	List Price
CO936	71	35.5	29	149	6.40	1	\$480

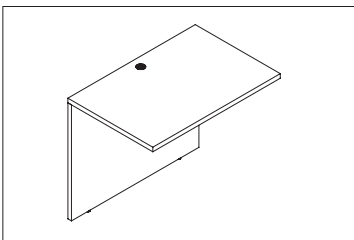

**Bridge**

Item	W	D	H	Weight lbs.	Cubic Ft.	Cartons	List Price
CO950	35	24	29	56	2.20	1	\$185
CO959	42	24	29	65	2.50	1	\$208
CO957	48	24	29	70	3.40	1	\$226

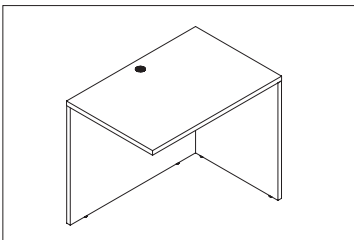

**Return**

Item	W	D	H	Weight lbs.	Cubic Ft.	Cartons	List Price
CO960	35	24	29	74	2.90	1	\$229
CO969	42	24	29	88	3.40	1	\$266
CO967	48	24	29	90	3.80	1	\$285

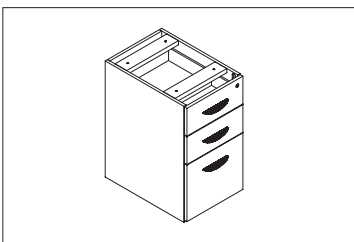

**Pedestal For Desk,B/B/F**

Item	W	D	H	Weight lbs.	Cubic Ft.	Cartons	List Price
CO713	15.5	22	28	78	7.00	1	\$449

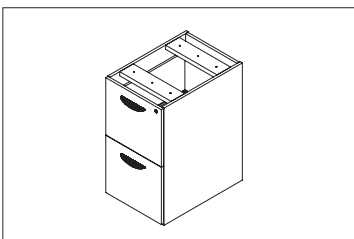

**Pedestal For Desk,F/F**

Item	W	D	H	Weight lbs.	Cubic Ft.	Cartons	List Price
CO712	15.5	22	28	74	7.00	1	\$406

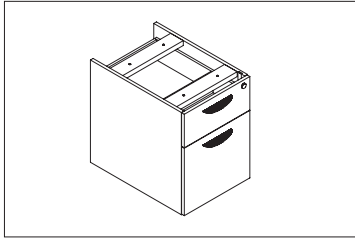

**Hanging Pedestal, B/F**

Item	W	D	H	Weight lbs.	Cubic Ft.	Cartons	List Price
CO702	15.5	22	20	61	5.30	1	\$325

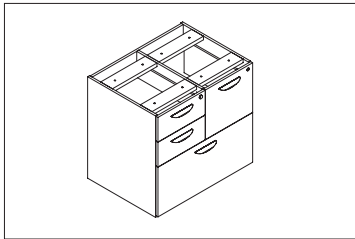

**Credenza Combo Lateral**

Item	W	D	H	Weight lbs.	Cubic Ft.	Cartons	List Price
CO734	30	22	28	154	16.40	1	\$798

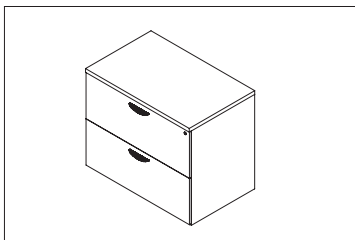

**Lateral Files, 2 Drawers**

Item	W	D	H	Weight lbs.	Cubic Ft.	Cartons	List Price
CO752	35.5	22.5	28	150	15.50	1	\$765

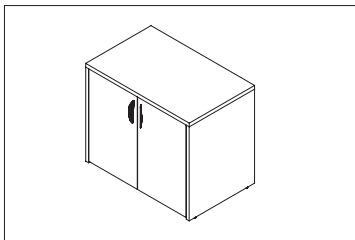

**Two Doors Cabinet**

Item	W	D	H	Weight lbs.	Cubic Ft.	Cartons	List Price
CO722	36	22	29	118	4.90	1	\$418

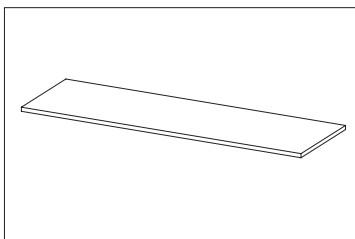

**Common Top**

Item	W	D	H	Weight lbs.	Cubic Ft.	Cartons	List Price
CO7235	71	22.5	1	45	1.00	1	\$165

For CO722/CO734/CO752

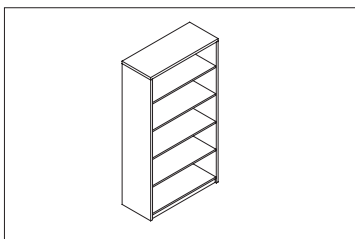

**Bookcase**

Item	W	D	H	Weight lbs.	Cubic Ft.	Cartons	List Price
CO522	35.5	15	65	150	6.60	1	\$475

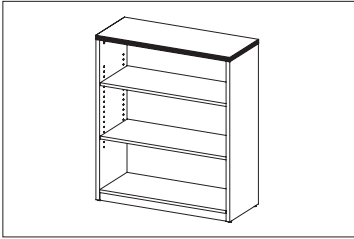

### Bookcase

Item	W	D	H	Weight lbs.	Cubic Ft.	Cartons	List Price
CO529	35.5	15	42	98	4.40	1	\$345

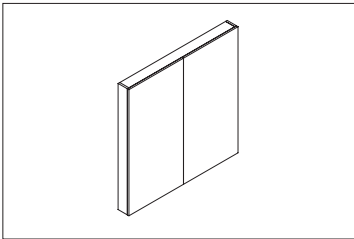

### Presentation Board

Item	W	D	H	Weight lbs.	Cubic Ft.	Cartons	List Price
CO422	48	4	48	102	8.50	1	\$544

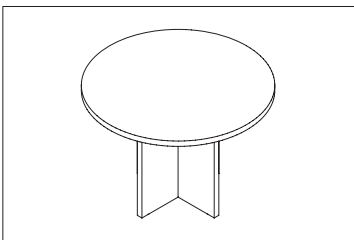

### Round Table

Item	W	D	H	Weight lbs.	Cubic Ft.	Cartons	List Price
CO479	42	42	29	95	6.00	1	\$485
CO477	47	47	29	109	7.50	1	\$515

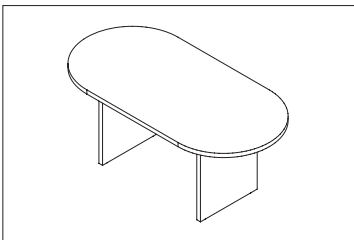

### Racetrack Table

Item	W	D	H	Weight lbs.	Cubic Ft.	Cartons	List Price
CO480	71	35	29	139	6.70	1	\$510
CO482	95	42	29	189	10.80	1	\$665

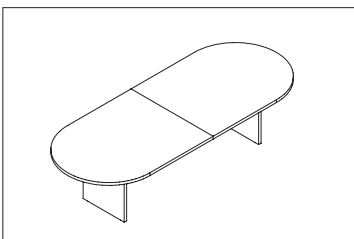

### Racetrack Table

Item	W	D	H	Weight lbs.	Cubic Ft.	Cartons	List Price
CO483	120	48	29	246	11.30	1	\$930

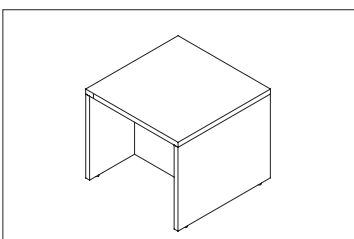

### End Table

Item	W	D	H	Weight lbs.	Cubic Ft.	Cartons	List Price
CO490	24	24	20	50	2.10	1	\$162

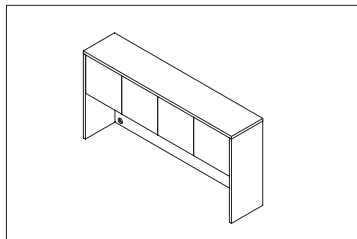

### Credenza Hutch

Item	W	D	H	Weight lbs.	Cubic Ft.	Cartons	List Price
CO300	71	15	36	140	6.10	1	\$520
CO320	66	15	36	128	5.70	1	\$480

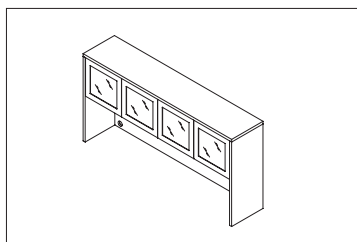

### 4 Frosted Doors Hutch

Item	W	D	H	Weight lbs.	Cubic Ft.	Cartons	List Price
CO304	71	15	36	142	6.10	1	\$748
CO324	66	15	36	130	5.70	1	\$718

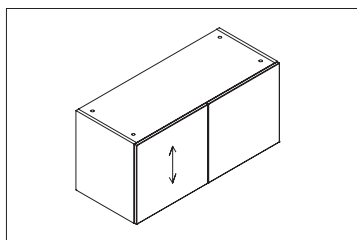

### Wall Mountable Overhead

Item	W	D	H	Weight lbs.	Cubic Ft.	Cartons	List Price
CO360	36	15	17	50	6.80	1	\$320

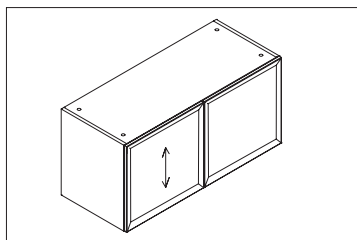

### 2 Frosted Doors Wall Mountable Overhead

Item	W	D	H	Weight lbs.	Cubic Ft.	Cartons	List Price
CO362	36	15	17	52	6.80	1	\$460

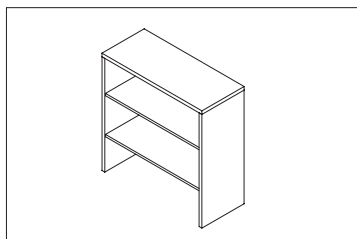

### Open Hutch

Item	W	D	H	Weight lbs.	Cubic Ft.	Cartons	List Price
CO390	35.5	15	36	81	4.00	1	\$280

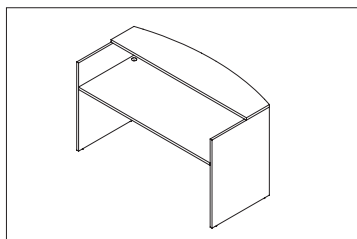

### Reception Desk Shell

Item	W	D	H	Weight lbs.	Cubic Ft.	Cartons	List Price
CO240	71	36	41	207	8.90	1	\$670



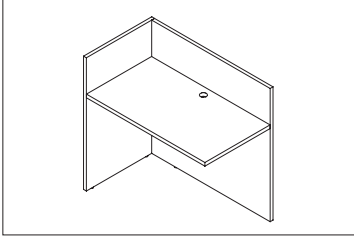

### Reception Return

Item	W	D	H	Weight lbs.	Cubic Ft.	Cartons	List Price
CO249	42	24	41	100	4.40	1	\$320

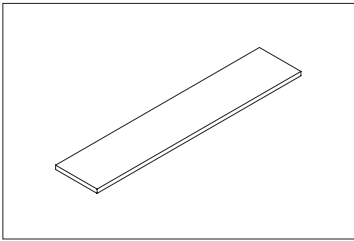

### Tackboard

Item	W	D	H	Weight lbs.	Cubic Ft.	Cartons	List Price
CO3001	68	1.5	18	25	1.80	1	\$176

For Hutch CO300 & CO304

CO3201	63	1.5	18	25	1.60	1	\$175
--------	----	-----	----	----	------	---	-------

For Hutch CO320 & CO324

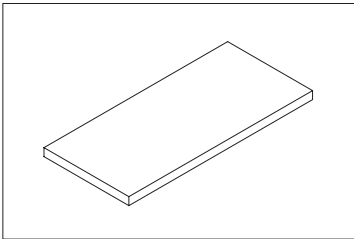

### Wood Keyboard Slide

Item	W	D	H	Weight lbs.	Cubic Ft.	Cartons	List Price
CO120	26	12	1	13	0.60	1	\$62

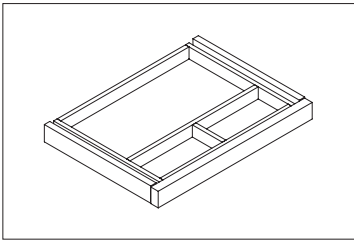

### Center Drawer

Item	W	D	H	Weight lbs.	Cubic Ft.	Cartons	List Price
CO130	20	15	2	9	0.80	1	\$62

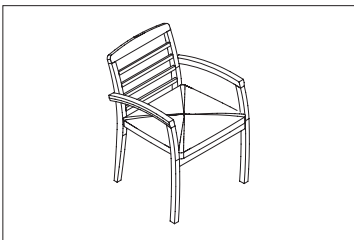

### Guest Chair

Item	W	D	H	Weight lbs.	Cubic Ft.	Cartons	List Price
Chair01	23	23	32.5	21	5.10	4pcs	\$450

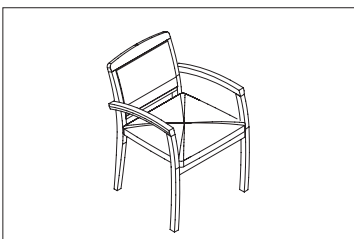

### Guest Chair

Item	W	D	H	Weight lbs.	Cubic Ft.	Cartons	List Price
Chair02	23	23	32.5	21	5.10	4pcs	\$450

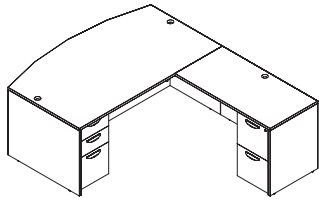

### L.Bow Desk Shell

Item	W	D	H	Weight lbs.	Cubic Ft.	Cartons	List Price
Layout 1							\$1,668
CO910	71	41	29	173	7.40	1	\$528
CO967	48	24	29	90	3.80	1	\$285
CO713	15.5	22	28	78	7.00	1	\$449
CO712	15.5	22	28	74	7.00	1	\$406

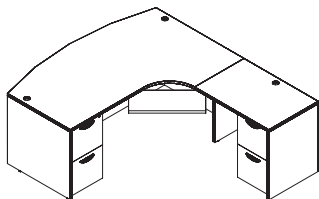

### L.Bow Desk Shell w/Corner

Item	W	D	H	Weight lbs.	Cubic Ft.	Cartons	List Price
Layout 2							\$1,698
CO916	71	48	29	184	8.40	1	\$595
CO960	35	24	29	74	2.90	1	\$229
CO712	15.5	22	28	74	7.00	1	\$406
CO712	15.5	22	28	74	7.00	1	\$406
CO120	26	12	1	13	0.60	1	\$62

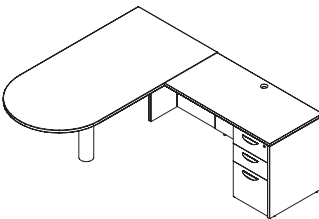

### L.Bullet

Item	W	D	H	Weight lbs.	Cubic Ft.	Cartons	List Price
Layout 4							\$1,190
CO920	71	35.5	29	117	6.90	1	\$456
CO967	48	24	29	90	3.80	1	\$285
CO713	15.5	22	28	78	7.00	1	\$449

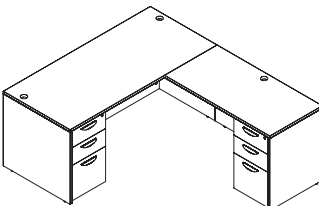

### L.Desk Shell

Item	W	D	H	Weight lbs.	Cubic Ft.	Cartons	List Price
Layout 5							\$1,573
CO902	66	30	29	136	5.50	1	\$390
CO967	48	24	29	90	3.80	1	\$285
CO713	15.5	22	28	78	7.00	1	\$449
CO713	15.5	22	28	78	7.00	1	\$449

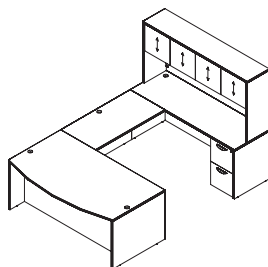

### U.Bow Desk Shell w/Hutch

Item	W	D	H	Weight lbs.	Cubic Ft.	Cartons	List Price
Layout 6							\$2,650
CO910	71	41	29	173	7.40	1	\$528
CO957	48	24	29	70	3.40	1	\$226
CO930	71	24	29	122	5.10	1	\$345
CO713	15.5	22	28	78	7.00	1	\$449
CO712	15.5	22	28	74	7.00	1	\$406
CO300	71	15	36	140	6.10	1	\$520
CO3001	68	1.5	18	25	1.80	1	\$176

### U.Bow Desk Shell w/Hutch

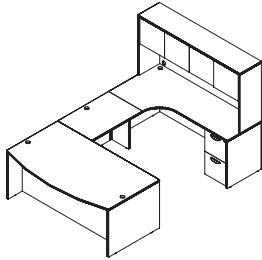

Item	W	D	H	Weight lbs.	Cubic Ft.	Cartons	List Price
Layout 7							\$2,744
CO910	71	41	29	173	7.40	1	\$528
CO950	35	24	29	56	2.20	1	\$185
CO937	71	35.5	29	149	6.40	1	\$480
CO713	15.5	22	28	78	7.00	1	\$449
CO712	15.5	22	28	74	7.00	1	\$406
CO300	71	15	36	140	6.10	1	\$520
CO3001	68	1.5	18	25	1.80	1	\$176

### U.Bow Desk Shell w/Hutch

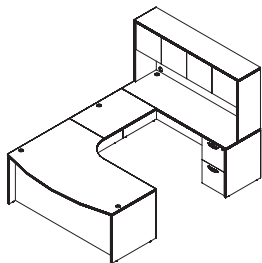

Item	W	D	H	Weight lbs.	Cubic Ft.	Cartons	List Price
Layout 8							\$2,676
CO916	71	48	29	184	8.40	1	\$595
CO950	35	24	29	56	2.20	1	\$185
CO930	71	24	29	122	5.10	1	\$345
CO713	15.5	22	28	78	7.00	1	\$449
CO712	15.5	22	28	74	7.00	1	\$406
CO300	71	15	36	140	6.10	1	\$520
CO3001	68	1.5	18	25	1.80	1	\$176

### U.Bullet w/Hutch

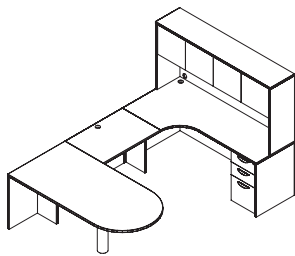

Item	W	D	H	Weight lbs.	Cubic Ft.	Cartons	List Price
Layout 9							\$2,266
CO920	71	35.5	29	117	6.90	1	\$456
CO950	35	24	29	56	2.20	1	\$185
CO937	71	35.5	29	149	6.40	1	\$480
CO713	15.5	22	28	78	7.00	1	\$449
CO300	71	15	36	140	6.10	1	\$520
CO3001	68	1.5	18	25	1.80	1	\$176

### Bow Desk Shell w/Credenza

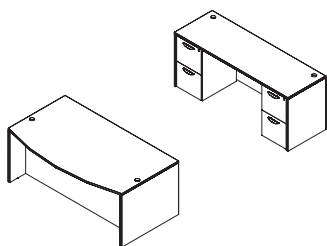

Item	W	D	H	Weight lbs.	Cubic Ft.	Cartons	List Price
Layout 11							\$2,583
CO910	71	41	29	173	7.40	1	\$528
CO713	15.5	22	28	78	7.00	1	\$449
CO713	15.5	22	28	78	7.00	1	\$449
CO712	15.5	22	28	74	7.00	1	\$406
CO712	15.5	22	28	74	7.00	1	\$406
CO930	71	24	29	122	5.10	1	\$345

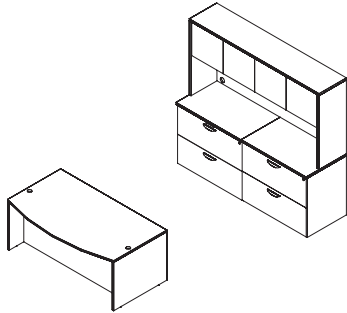

### Bow Desk Shell w/Hutch

Item	W	D	H	Weight lbs.	Cubic Ft.	Cartons	List Price
Layout 12							\$3,652
CO910	71	41	29	173	7.40	1	\$528
CO713	15.5	22	28	78	7.00	1	\$449
CO713	15.5	22	28	78	7.00	1	\$449
CO752	35.5	22.5	28	150	15.50	1	\$765
CO752	35.5	22.5	28	150	15.50	1	\$765
CO300	71	15	36	140	6.10	1	\$520
CO3001	68	1.5	18	25	1.80	1	\$176

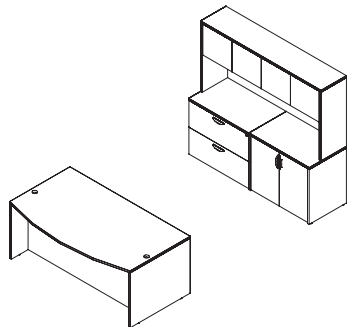

### Bow Desk Shell w/Hutch

Item	W	D	H	Weight lbs.	Cubic Ft.	Cartons	List Price
Layout 13							\$3,305
CO910	71	41	29	173	7.40	1	\$528
CO713	15.5	22	28	78	7.00	1	\$449
CO713	15.5	22	28	78	7.00	1	\$449
CO752	35.5	22.5	28	150	15.50	1	\$765
CO722	36	22	29	118	4.90	1	\$418
CO300	71	15	36	140	6.10	1	\$520
CO3001	68	1.5	18	25	1.80	1	\$176

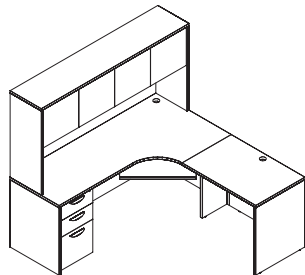

### L.Credenza w/Hutch

Item	W	D	H	Weight lbs.	Cubic Ft.	Cartons	List Price
Layout 15							\$1,916
CO936	71	35.5	29	149	6.40	1	\$480
CO960	35	24	29	74	2.90	1	\$229
CO713	15.5	22	28	78	7.00	1	\$449
CO300	71	15	36	140	6.10	1	\$520
CO3001	68	1.5	18	25	1.80	1	\$176
CO120	26	12	1	13	0.60	1	\$62

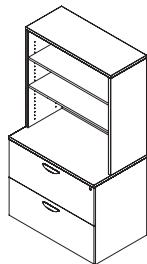

### Lateral Files w/Open Hutch

Item	W	D	H	Weight lbs.	Cubic Ft.	Cartons	List Price
Layout 16							\$1,045
CO752	35.5	22.5	28	150	15.50	1	\$765
CO390	35.5	15	36	81	4.00	1	\$280

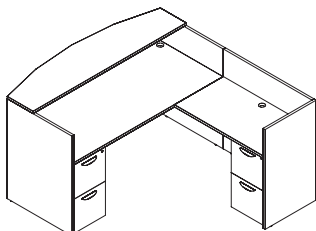

### Reception

Item	W	D	H	Weight lbs.	Cubic Ft.	Cartons	List Price
Layout 17							\$1,802
CO240	71	36	41	207	8.90	1	\$670
CO249	42	24	41	100	4.40	1	\$320
CO712	15.5	22	28	74	7.00	1	\$406
CO712	15.5	22	28	74	7.00	1	\$406

### U.Bow Desk w/Bookcase

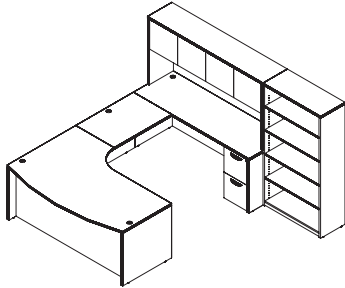

Item	W	D	H	Weight lbs.	Cubic Ft.	Cartons	List Price
Layout 18							\$3,151
CO916	71	48	29	184	8.40	1	\$595
CO950	35	24	29	56	2.20	1	\$185
CO930	71	24	29	122	5.10	1	\$345
CO713	15.5	22	28	78	7.00	1	\$449
CO712	15.5	22	28	74	7.00	1	\$406
CO300	71	15	36	140	6.10	1	\$520
CO3001	68	1.5	18	25	1.80	1	\$176
CO522	35.5	15	65	150	6.60	1	\$475

### U.Bullet w/Lateral Files

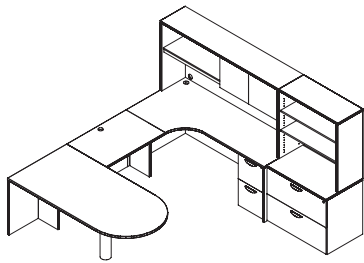

Item	W	D	H	Weight lbs.	Cubic Ft.	Cartons	List Price
Layout 19							\$3,311
CO920	71	35.5	29	117	6.90	1	\$456
CO950	35	24	29	56	2.20	1	\$185
CO937	71	35.5	29	149	6.40	1	\$480
CO713	15.5	22	28	78	7.00	1	\$449
CO300	71	15	36	140	6.10	1	\$520
CO3001	68	1.5	18	25	1.80	1	\$176
CO752	35.5	22.5	28	150	15.50	1	\$765
CO390	35.5	15	36	81	4.00	1	\$280

### U.Bow Desk Shell w/FD Hutch

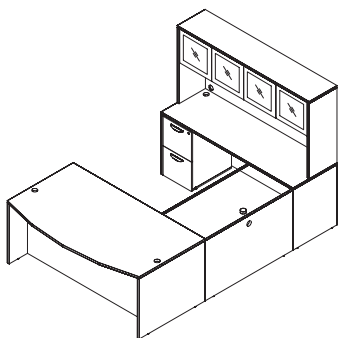

Item	W	D	H	Weight lbs.	Cubic Ft.	Cartons	List Price
Layout 21							\$2,860
CO910	71	41	29	173	7.40	1	\$528
CO959	42	24	29	65	2.50	1	\$208
CO930	71	24	29	122	5.10	1	\$345
CO713	15.5	22	28	78	7.00	1	\$449
CO712	15.5	22	28	74	7.00	1	\$406
CO304	71	15	36	142	6.10	1	\$748
CO3001	68	1.5	18	25	1.80	1	\$176

### U.Desk Shell w/FD Hutch

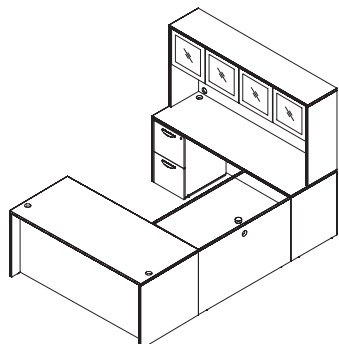

Item	W	D	H	Weight lbs.	Cubic Ft.	Cartons	List Price
Layout 22							\$2,817
CO900	71	35.5	29	162	6.40	1	\$485
CO959	42	24	29	65	2.50	1	\$208
CO930	71	24	29	122	5.10	1	\$345
CO713	15.5	22	28	78	7.00	1	\$449
CO712	15.5	22	28	74	7.00	1	\$406
CO304	71	15	36	142	6.10	1	\$748
CO3001	68	1.5	18	25	1.80	1	\$176

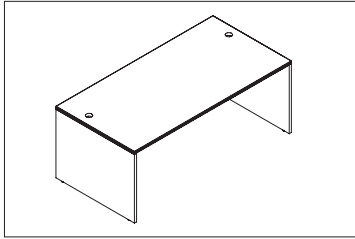

**Desk Shell**

Item	W	D	H	Weight lbs.	Cubic Ft.	Cartons	List Price
AN900	72	36	29	173	7.00	1	\$1,390
AN902	66	30	29	135	5.30	1	\$1,175

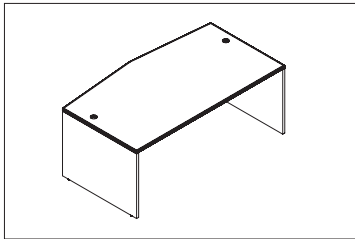

**Bow Front Desk Shell**

Item	W	D	H	Weight lbs.	Cubic Ft.	Cartons	List Price
AN910	72	39	29	180	7.80	1	\$1,493

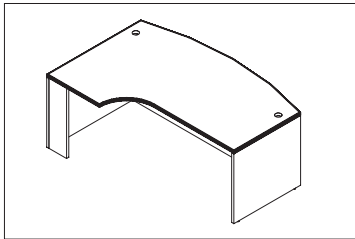

**Bow Front Desk w/Corner(L)**

Item	W	D	H	Weight lbs.	Cubic Ft.	Cartons	List Price
AN917	72	48	29	175	9.00	1	\$1,699

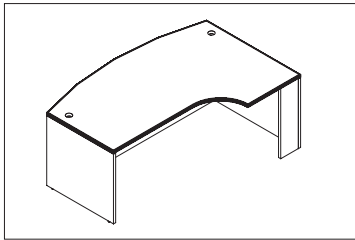

**Bow Front Desk w/Corner(R)**

Item	W	D	H	Weight lbs.	Cubic Ft.	Cartons	List Price
AN916	72	48	29	175	9.00	1	\$1,699

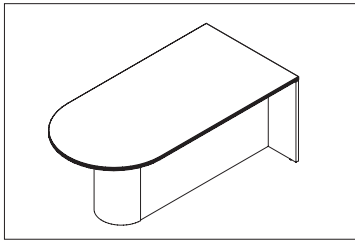

**Bullet Desk**

Item	W	D	H	Weight lbs.	Cubic Ft.	Cartons	List Price
AN920	72	36	29	151	10.60	1	\$1,405
AN9201				17	3.0	1	

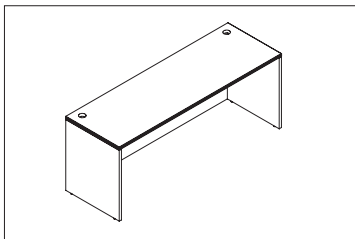

**Credenza Shell**

Item	W	D	H	Weight lbs.	Cubic Ft.	Cartons	List Price
AN930	72	20	29	108	5.50	1	\$1,005
AN932	66	20	29	104	5.00	1	\$946

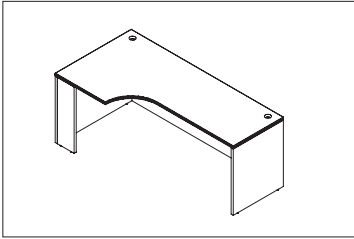

**Corner Credenza w/Corner(L)**

Item	W	D	H	Weight lbs.	Cubic Ft.	Cartons	List Price
AN937	72	36	29	145	7.20	1	\$1,364

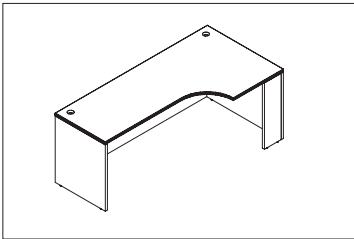

**Corner Credenza w/Corner(R)**

Item	W	D	H	Weight lbs.	Cubic Ft.	Cartons	List Price
AN936	72	36	29	145	7.20	1	\$1,364

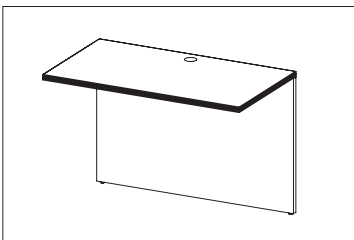

**Bridge**

Item	W	D	H	Weight lbs.	Cubic Ft.	Cartons	List Price
AN950	36	24	29	46	2.35	1	\$485
AN959	42	24	29	47	2.85	1	\$531
AN957	48	24	29	49	3.00	1	\$595

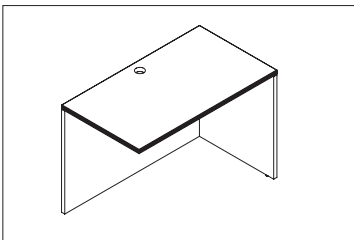

**Return**

Item	W	D	H	Weight lbs.	Cubic Ft.	Cartons	List Price
AN960	36	24	29	65	3.00	1	\$573
AN969	42	24	29	78	3.40	1	\$646
AN967	48	24	29	81	3.70	1	\$703

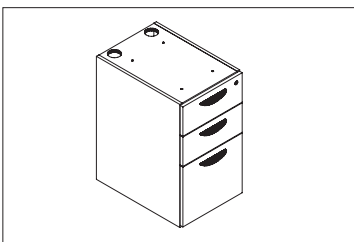

**Pedestal For Desk,B/B/F**

Item	W	D	H	Weight lbs.	Cubic Ft.	Cartons	List Price
AN713	15.5	24.5	27.5	73	8.10	1	\$822

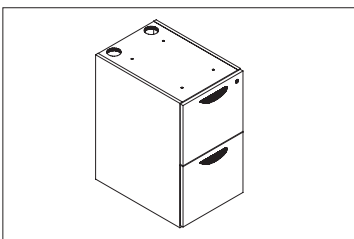

**Pedestal For Desk,F/F**

Item	W	D	H	Weight lbs.	Cubic Ft.	Cartons	List Price
AN712	15.5	24.5	27.5	71	8.10	1	\$688

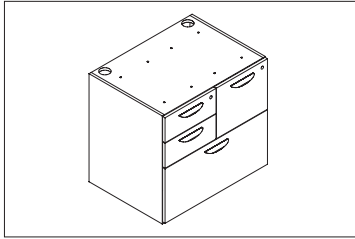

### Credenza Combo Lateral

Item	W	D	H	Weight lbs.	Cubic Ft.	Cartons	List Price
AN734	30	18.5	27.5	97	11.50	1	\$1,388

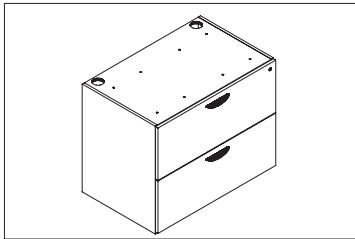

### Credenza Lateral Files, 2 Drawers

Item	W	D	H	Weight lbs.	Cubic Ft.	Cartons	List Price
AN752	35	18.5	27.5	140	12.00	1	\$1,192

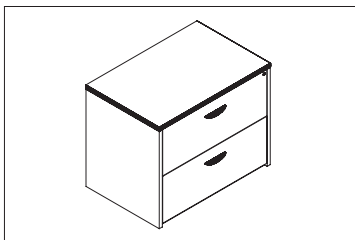

### Lateral Files, 2 Drawers

Item	W	D	H	Weight lbs.	Cubic Ft.	Cartons	List Price
AN753	35	18.5	29.5	143	12.00	1	\$1,504

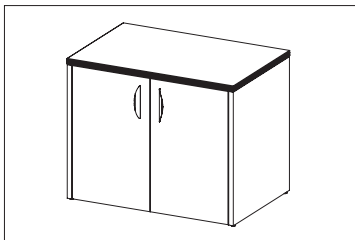

### Two Doors Cabinet

Item	W	D	H	Weight lbs.	Cubic Ft.	Cartons	List Price
AN722	37	20	29	110	15.50	1	\$1,300

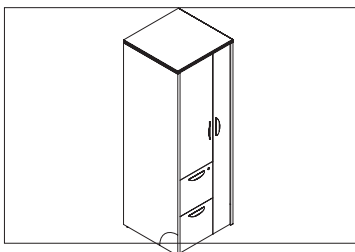

### Wardrobe

Item	W	D	H	Weight lbs.	Cubic Ft.	Cartons	List Price
AN730	24	24	70	220	32.00	1	\$2,387

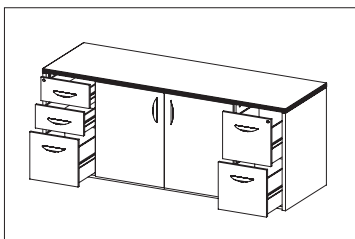

### Lateral Credenza

Item	W	D	H	Weight lbs.	Cubic Ft.	Cartons	List Price
AN740	72	20	29	240	29.50	1	\$2,785



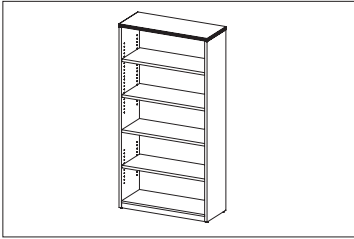

**Bookcase**

Item	W	D	H	Weight lbs.	Cubic Ft.	Cartons	List Price
AN521	36	14	70	160	7.50	1	\$1,389

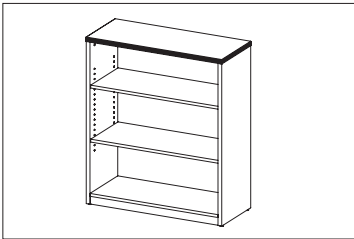

**Bookcase**

Item	W	D	H	Weight lbs.	Cubic Ft.	Cartons	List Price
AN529	36	14	42	98	4.80	1	\$902

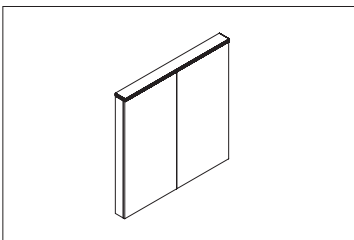

**Presentation Board**

Item	W	D	H	Weight lbs.	Cubic Ft.	Cartons	List Price
AN422	48	4	48	118	9.40	1	\$1,416

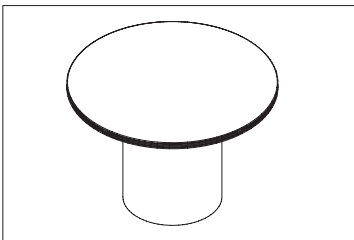

**Round Table**

Item	W	D	H	Weight lbs.	Cubic Ft.	Cartons	List Price
AN479	42	42	29	87	11.20	1	\$1,056
AN4791						1	
AN477	48	48	29	105	15.50	1	\$1,318
AN4771						1	

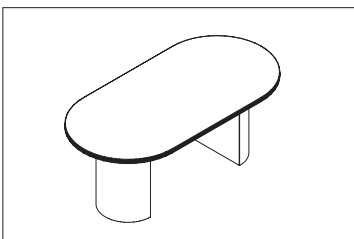

**Racetrack Table**

Item	W	D	H	Weight lbs.	Cubic Ft.	Cartons	List Price
AN480	72	36	29	125	12.50	1	\$1,583
AN4801						1	
AN4802						1	

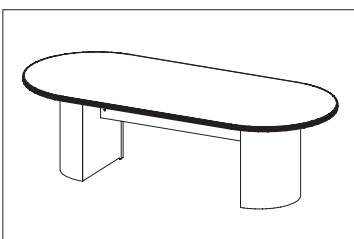

**Racetrack Table**

Item	W	D	H	Weight lbs.	Cubic Ft.	Cartons	List Price
AN482	96	42	29	190	18.90	1	\$2,047
AN4821						1	
AN4822						1	

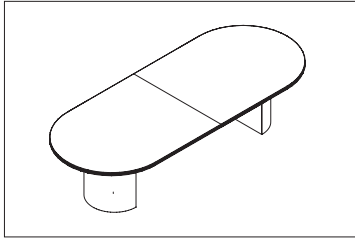

**Racetrack Table**

Item	W	D	H	Weight lbs.	Cubic Ft.	Cartons	List Price
AN483	120	48	29	239	20.50	1	\$2,585
AN4831						1	
AN4822						1	

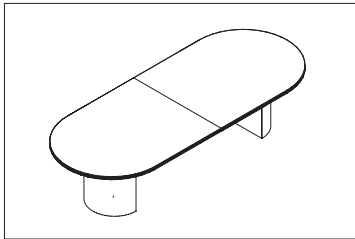

**Racetrack Table**

Item	W	D	H	Weight lbs.	Cubic Ft.	Cartons	List Price
AN485	144	48	29	280	21.50	1	\$3,298
AN4851						1	
AN4822						1	

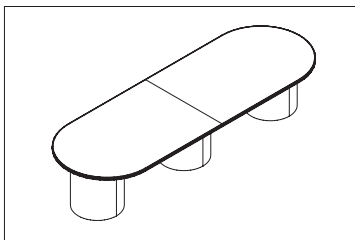

**Racetrack Table**

Item	W	D	H	Weight lbs.	Cubic Ft.	Cartons	List Price
AN487	168	48	29	356	35.00	1	\$4,163
AN4872						1	

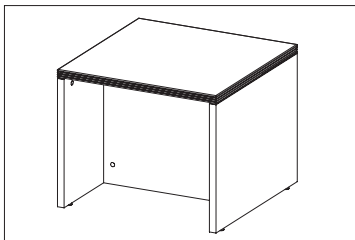

**End Table**

Item	W	D	H	Weight lbs.	Cubic Ft.	Cartons	List Price
AN490	24	24	20	32	1.90	1	\$430

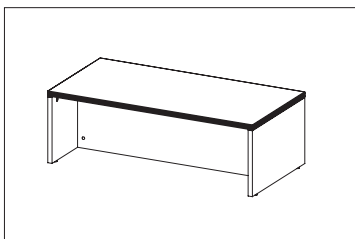

**Coffee Table**

Item	W	D	H	Weight lbs.	Cubic Ft.	Cartons	List Price
AN497	48	24	16	50	4.20	1	\$599

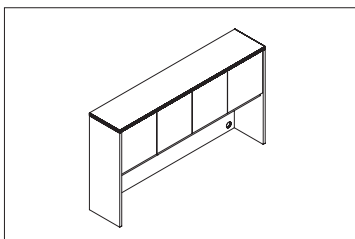

**Credenza Hutch**

Item	W	D	H	Weight lbs.	Cubic Ft.	Cartons	List Price
AN300	72	15	42	165	32.00	1	\$1,722
AN320	66	15	42	158	29.00	1	\$1,617

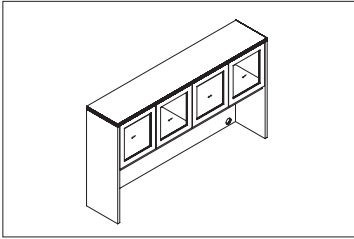

### 4 Frosted Doors Hutch

Item	W	D	H	Weight lbs.	Cubic Ft.	Cartons	List Price
AN304	72	15	42	166	32.00	1	\$1,961
AN324	66	15	42	159	29.00	1	\$1,856

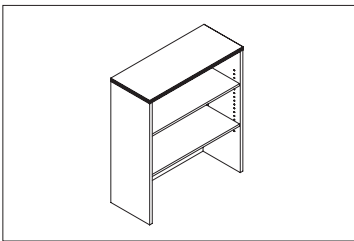

### Open Hutch

Item	W	D	H	Weight lbs.	Cubic Ft.	Cartons	List Price
AN390	36	14	42	98	4.50	1	\$938

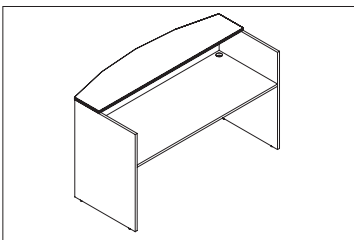

### Reception Desk Shell

Item	W	D	H	Weight lbs.	Cubic Ft.	Cartons	List Price
AN240	72	36	43	248	9.50	1	\$1,961

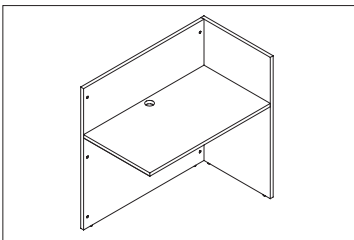

### Reception Return

Item	W	D	H	Weight lbs.	Cubic Ft.	Cartons	List Price
AN249	42	20	43	95	3.80	1	\$817

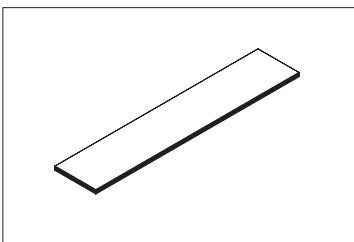

### Tackboard

Item	W	D	H	Weight lbs.	Cubic Ft.	Cartons	List Price
AN3001	69	1.5	19.5	10	1.20	1	\$220
For Hutch AN300 & AN304							
AN3201	63	1.5	19.5	9.5	1.10	1	\$200
For Hutch AN320 & AN324							

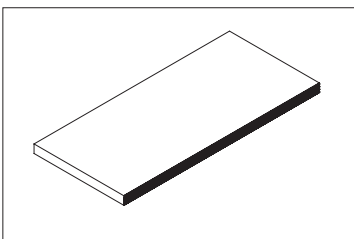

### Wood Keyboard Slide

Item	W	D	H	Weight lbs.	Cubic Ft.	Cartons	List Price
AN120	22	12	1	12	1.10	1	\$105

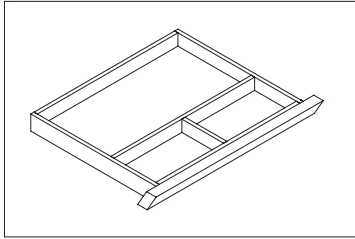

### Center Drawer

Item	W	D	H	Weight lbs.	Cubic Ft.	Cartons	List Price
AN130	20	14	1	9	0.80	1	\$85

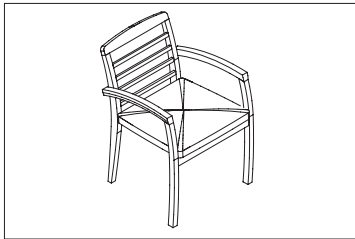

### Guest Chair

Item	W	D	H	Weight lbs.	Cubic Ft.	Cartons	List Price
Chair01	23	23	32.5	21	5.10	4pcs	\$450

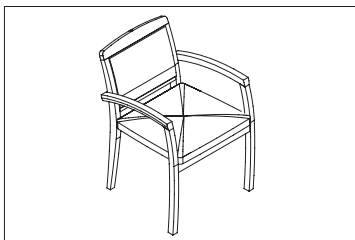

### Guest Chair

Item	W	D	H	Weight lbs.	Cubic Ft.	Cartons	List Price
Chair02	23	23	32.5	21	5.10	4pcs	\$450

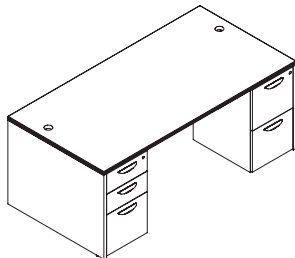

### Desk Shell

Item	W	D	H	Weight lbs.	Cubic Ft.	Cartons	List Price
Layout1							\$2,900
AN900	72	36	29	173	7.00	1	\$1,390
AN713	15.5	24.5	27.5	73	8.10	1	\$822
AN712	15.5	24.5	27.5	71	8.10	1	\$688

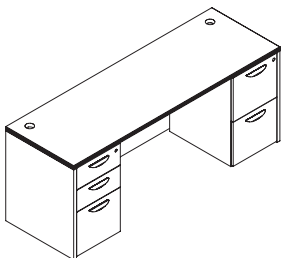

### Credenza Shell

Item	W	D	H	Weight lbs.	Cubic Ft.	Cartons	List Price
Layout2							\$2,515
AN930	72	20	29	108	5.50	1	\$1,005
AN713	15.5	24.5	27.5	73	8.10	1	\$822
AN712	15.5	24.5	27.5	71	8.10	1	\$688

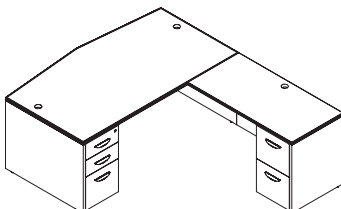

### L.Bow Desk Shell

Item	W	D	H	Weight lbs.	Cubic Ft.	Cartons	List Price
Layout3							\$3,706
AN910	72	39	29	180	7.80	1	\$1,493
AN967	48	24	29	81	3.70	1	\$703
AN713	15.5	24.5	27.5	73	8.10	1	\$822
AN712	15.5	24.5	27.5	71	8.10	1	\$688

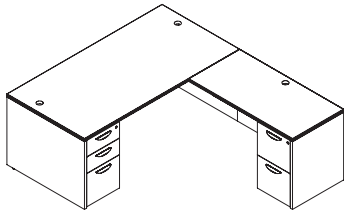

### L.Desk Shell

Item	W	D	H	Weight lbs.	Cubic Ft.	Cartons	List Price
Layout4							\$3,388
AN902	66	30	29	135	5.30	1	\$1,175
AN967	48	24	29	81	3.70	1	\$703
AN713	15.5	24.5	27.5	73	8.10	1	\$822
AN712	15.5	24.5	27.5	71	8.10	1	\$688

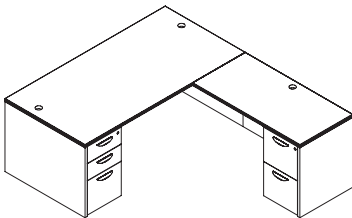

### L.Desk Shell

Item	W	D	H	Weight lbs.	Cubic Ft.	Cartons	List Price
Layout5							\$3,603
AN900	72	36	29	173	7.70	1	\$1,390
AN967	48	24	29	81	3.70	1	\$703
AN713	15.5	24.5	27.5	73	8.10	1	\$822
AN712	15.5	24.5	27.5	71	8.10	1	\$688

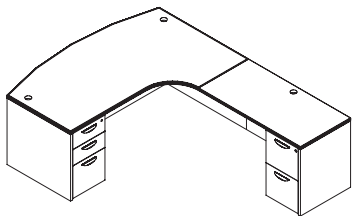

### L.Bow Desk Shell w/Corner

Item	W	D	H	Weight lbs.	Cubic Ft.	Cartons	List Price
Layout6							\$3,912
AN916	72	48	29	175	9	1	\$1,699
AN967	48	24	29	81	3.70	1	\$703
AN713	15.5	24.5	27.5	73	8.10	1	\$822
AN712	15.5	24.5	27.5	71	8.10	1	\$688

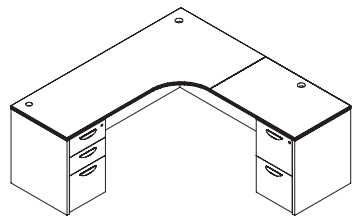

### L.Credenza Shell w/Corner

Item	W	D	H	Weight lbs.	Cubic Ft.	Cartons	List Price
Layout7							\$3,447
AN936	72	36	29	145	7.20	1	\$1,364
AN960	36	24	29	65	3.00	1	\$573
AN713	15.5	24.5	27.5	73	8.10	1	\$822
AN712	15.5	24.5	27.5	71	8.10	1	\$688

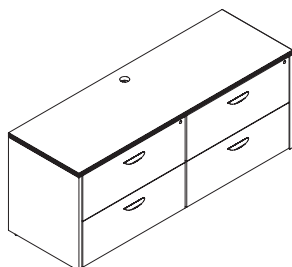

### Credenza w/Lateral Files

Item	W	D	H	Weight lbs.	Cubic Ft.	Cartons	List Price
Layout10							\$3,389
AN930	72	20	29	108	5.50	1	\$1,005
AN752	35	18.5	27.5	140	12.00	1	\$1,192
AN752	35	18.5	27.5	140	12.00	1	\$1,192

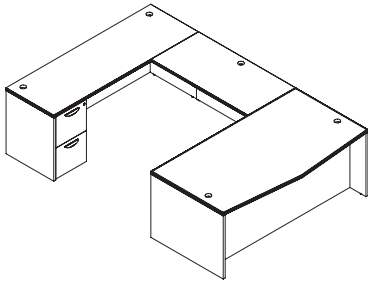

### U.Bow Desk Shell

Item	W	D	H	Weight lbs.	Cubic Ft.	Cartons	List Price
Layout11							\$4,603
AN910	72	39	29	180	7.80	1	\$1,493
AN957	48	24	29	49	3.00	1	\$595
AN930	72	20	29	108	5.50	1	\$1,005
AN713	15.5	24.5	27.5	73	8.10	1	\$822
AN712	15.5	24.5	27.5	71	8.10	1	\$688

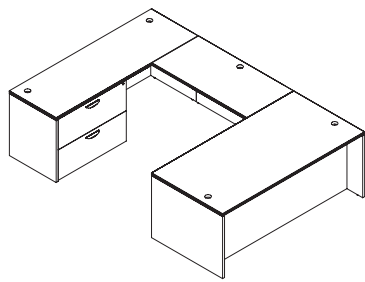

### U.Desk Shell

Item	W	D	H	Weight lbs.	Cubic Ft.	Cartons	List Price
Layout12							\$5,004
AN900	72	36	29	173	7.00	1	\$1,390
AN957	48	24	29	49	3.00	1	\$595
AN930	72	20	29	108	5.50	1	\$1,005
AN713	15.5	24.5	27.5	73	8.10	1	\$822
AN752	35	18.5	27.5	140	12.00	1	\$1,192

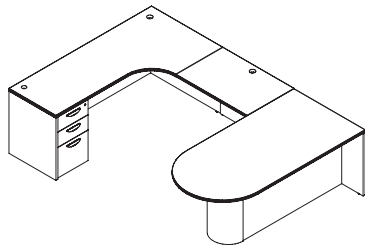

### U.Bullet Desk Shell

Item	W	D	H	Weight lbs.	Cubic Ft.	Cartons	List Price
Layout13							\$4,076
AN920	72	36	29	151	10.60	2	\$1,405
AN950	36	24	29	46	2.35	1	\$485
AN936	72	36	29	145	7.20	1	\$1,364
AN713	15.5	24.5	27.5	73	8.10	1	\$822

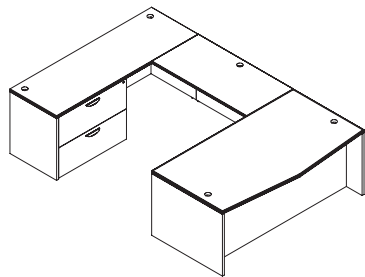

### U.Bow Desk Shell

Item	W	D	H	Weight lbs.	Cubic Ft.	Cartons	List Price
Layout14							\$4,285
AN910	72	39	29	180	7.80	1	\$1,493
AN957	48	24	29	49	3.00	1	\$595
AN930	72	20	29	108	5.50	1	\$1,005
AN752	35	18.5	27.5	140	12.00	1	\$1,192

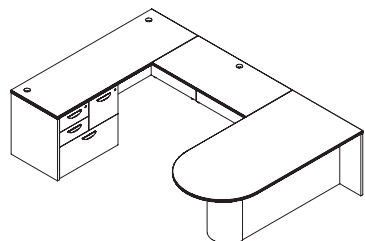

### U.Bullet Desk

Item	W	D	H	Weight lbs.	Cubic Ft.	Cartons	List Price
Layout16							\$4,393
AN920	72	36	29	151	10.60	2	\$1,405
AN957	48	24	29	49	3.00	1	\$595
AN930	72	20	29	108	5.50	1	\$1005
AN734	30	18.5	27.5	97	11.50	1	\$1,388

**U.Desk Shell**

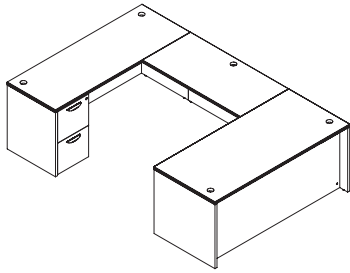

Item	W	D	H	Weight lbs.	Cubic Ft.	Cartons	List Price
Layout17							\$4,226
AN902	66	30	29	135	5.30	1	\$1,175
AN957	48	24	29	49	3.00	1	\$595
AN932	66	20	29	104	5.00	1	\$946
AN713	15.5	24.5	27.5	73	8.10	1	\$822
AN712	15.5	24.5	27.5	71	8.10	1	\$688

**U.Desk Shell**

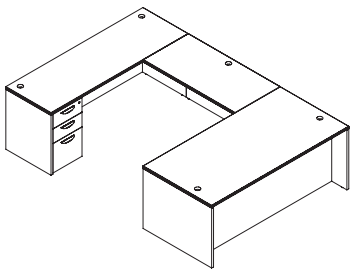

Item	W	D	H	Weight lbs.	Cubic Ft.	Cartons	List Price
Layout19							\$4,500
AN900	72	36	29	173	7.00	1	\$1,390
AN957	48	24	29	49	3.00	1	\$595
AN930	72	20	29	108	5.50	1	\$1,005
AN713	15.5	24.5	27.5	73	8.10	1	\$822
AN712	15.5	24.5	27.5	71	8.10	1	\$688

**U.Bow Desk Corner w/Hutch**

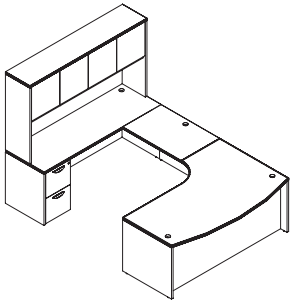

Item	W	D	H	Weight lbs.	Cubic Ft.	Cartons	List Price
Layout21							\$6,421
AN917	72	48	29	175	9.00	1	\$1,699
AN950	36	24	29	46	2.35	1	\$485
AN930	72	20	29	108	5.50	1	\$1,005
AN713	15.5	24.5	27.5	73	8.10	1	\$822
AN712	15.5	24.5	27.5	71	8.10	1	\$688
AN300	72	15	42	165	32.00	1	\$1,722

**U.Credenza Corner w/Hutch**

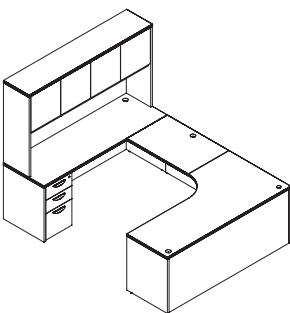

Item	W	D	H	Weight lbs.	Cubic Ft.	Cartons	List Price
Layout22							\$6,086
AN937	72	36	29	145	7.20	1	\$1,364
AN950	36	24	29	46	2.35	1	\$485
AN930	72	20	29	108	5.50	1	\$1,005
AN713	15.5	24.5	27.5	73	8.10	1	\$822
AN712	15.5	24.5	27.5	71	8.10	1	\$688
AN300	72	15	42	165	32.00	1	\$1,722

**U.Bow Desk w/Lateral Files**

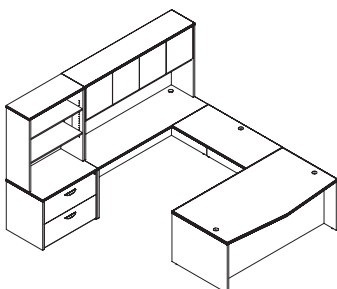

Item	W	D	H	Weight lbs.	Cubic Ft.	Cartons	List Price
Layout23							\$8,767
AN910	72	39	29	180	7.80	1	\$1,493
AN957	48	24	29	49	3.00	1	\$595
AN930	72	20	29	108	5.50	1	\$1,005
AN713	15.5	24.5	27.5	73	8.10	1	\$822
AN712	15.5	24.5	27.5	71	8.10	1	\$688
AN300	72	15	42	165	32.00	1	\$1,722
AN753	35	18.5	29.5	143	12.00	1	\$1,504
AN390	36	14	42	98	4.50	1	\$938

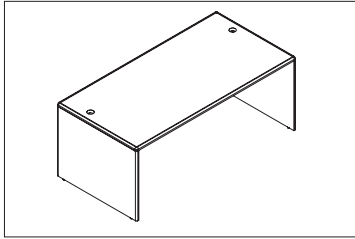

### Desk Shell

Item	W	D	H	Weight lbs.	Cubic Ft.	Cartons	List Price
RO900	72	36	29	175	7.50	1	\$1,335
RO902	66	30	29	143	5.30	1	\$1,120

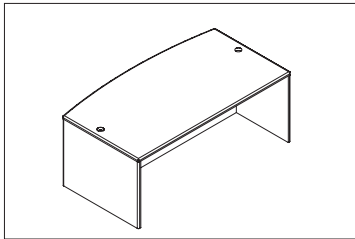

### Bow Front Desk Shell

Item	W	D	H	Weight lbs.	Cubic Ft.	Cartons	List Price
RO910	72	39	29	180	7.80	1	\$1,398

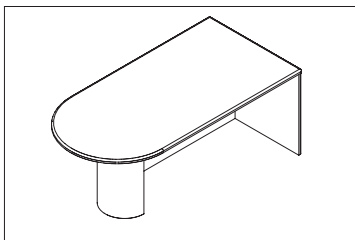

### Bullet Desk

Item	W	D	H	Weight lbs.	Cubic Ft.	Cartons	List Price
RO920	72	36	29	134	8.10	1	\$1,413
RO9201				17	2.50	1	

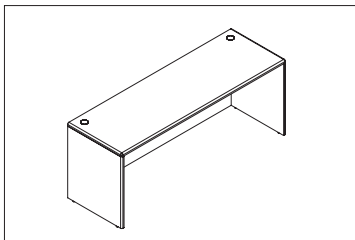

### Credenza Shell

Item	W	D	H	Weight lbs.	Cubic Ft.	Cartons	List Price
RO930	72	20	29	114	5.80	1	\$946
RO932	66	20	29	104	5.40	1	\$898

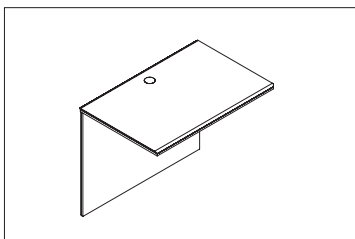

### Bridge

Item	W	D	H	Weight lbs.	Cubic Ft.	Cartons	List Price
RO957	48	24	29	66	3.00	1	\$552
RO959	42	24	29	57	2.85	1	\$496

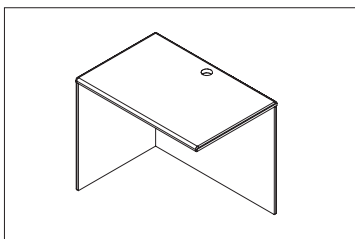

### Return-Left/Right

Item	W	D	H	Weight lbs.	Cubic Ft.	Cartons	List Price
RO967	48	24	29	81	3.90	1	\$677
RO969	42	24	29	78	3.60	1	\$601



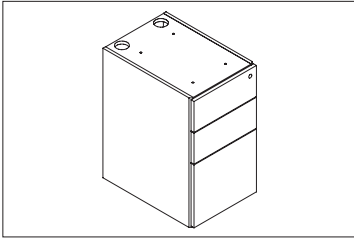

**Pedestal For Desk,B/B/F**

Item	W	D	H	Weight lbs.	Cubic Ft.	Cartons	List Price
RO713	15.5	24.5	27.5	71	7.10	1	\$774

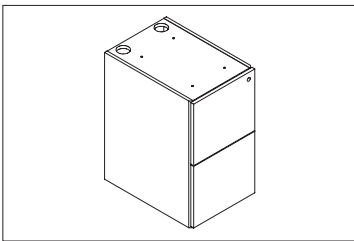

**Pedestal For Desk,F/F**

Item	W	D	H	Weight lbs.	Cubic Ft.	Cartons	List Price
RO712	15.5	24.5	27.5	67	7.00	1	\$647

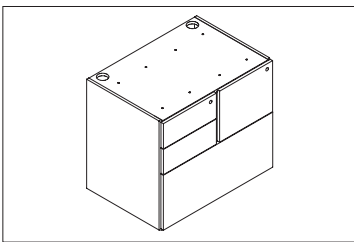

**Credenza Combo Lateral**

Item	W	D	H	Weight lbs.	Cubic Ft.	Cartons	List Price
RO734	30	18.5	27.5	115	12.20	1	\$1,865

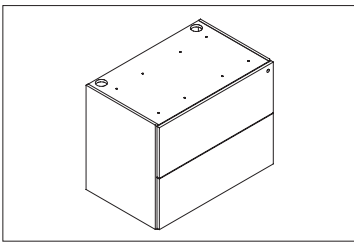

**Credenza Lateral Files,2 Drawers**

Item	W	D	H	Weight lbs.	Cubic Ft.	Cartons	List Price
RO752	35	18.5	27.5	94	12.80	1	\$1,091

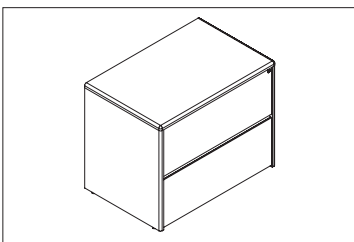

**Lateral Files,2 Drawers**

Item	W	D	H	Weight lbs.	Cubic Ft.	Cartons	List Price
RO753	37	20	29	139	15.50	1	\$1,387

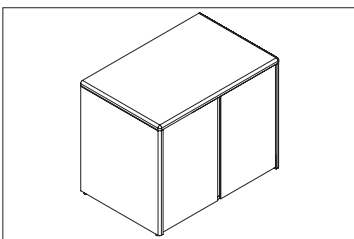

**Two Doors Cabinet**

Item	W	D	H	Weight lbs.	Cubic Ft.	Cartons	List Price
RO722	37	20	29	112	15.50	1	\$1,253

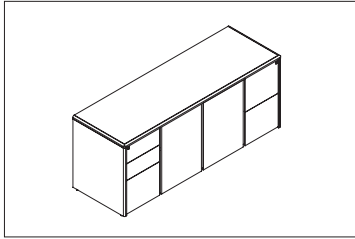

### Lateral Credenza

Item	W	D	H	Weight lbs.	Cubic Ft.	Cartons	List Price
RO740	72	20	29	240	29.50	1	\$2,635

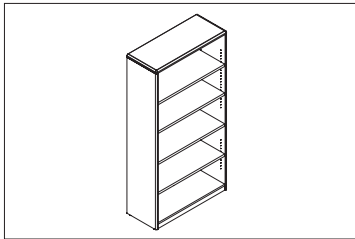

### Bookcase

Item	W	D	H	Weight lbs.	Cubic Ft.	Cartons	List Price
RO521	36	14	70	153	7.50	1	\$1,326

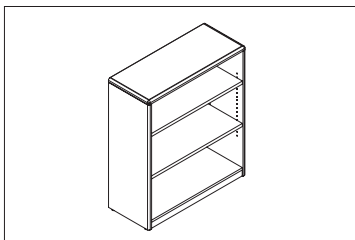

### Bookcase

Item	W	D	H	Weight lbs.	Cubic Ft.	Cartons	List Price
RO529	36	14	42	98	4.70	1	\$885

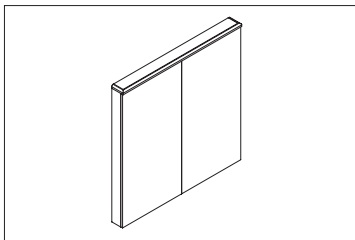

### Presentation Board

Item	W	D	H	Weight lbs.	Cubic Ft.	Cartons	List Price
RO422	48	4	48	133	8.50	1	\$1,286

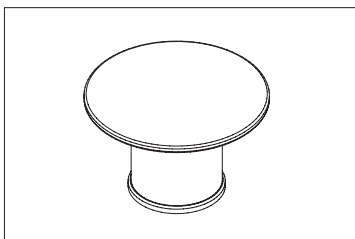

### Round Table

Item	W	D	H	Weight lbs.	Cubic Ft.	Cartons	List Price
RO479	42	42	29	87	11.50	1	\$990
RO4791						1	
RO477	48	48	29	105	16.00	1	\$1,250
RO4771						1	

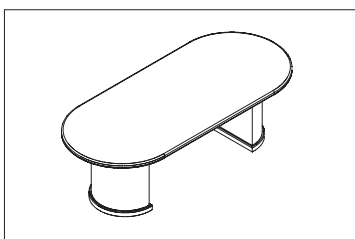

### Racetrack Table

Item	W	D	H	Weight lbs.	Cubic Ft.	Cartons	List Price
RO480	72	36	29	138	13.84	1	\$1,520
RO4801						1	
RO4802						1	

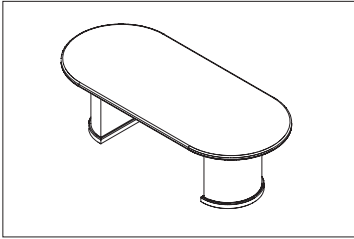

### Racetrack Table

Item	W	D	H	Weight lbs.	Cubic Ft.	Cartons	List Price
RO482	96	42	29	205	19.90	1	\$1,925
RO4821						1	
RO4822						1	

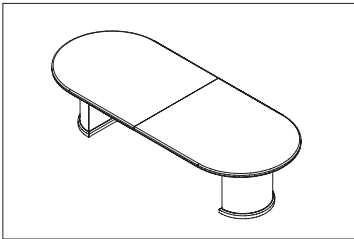

### Racetrack Table

Item	W	D	H	Weight lbs.	Cubic Ft.	Cartons	List Price
RO483	120	48	29	270	22.50	1	\$2,380
RO4831						1	
RO4822						1	

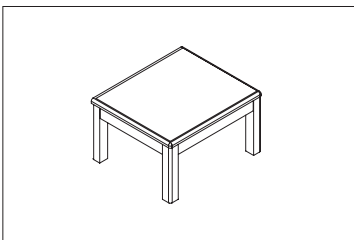

### End Table

Item	W	D	H	Weight lbs.	Cubic Ft.	Cartons	List Price
RO490	24	24	20	40	1.90	1	\$410

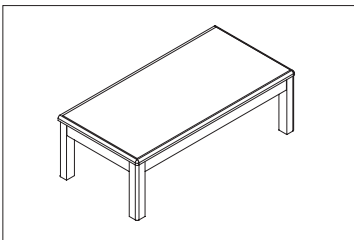

### Coffee Table

Item	W	D	H	Weight lbs.	Cubic Ft.	Cartons	List Price
RO497	48	24	16	62	3.80	1	\$580

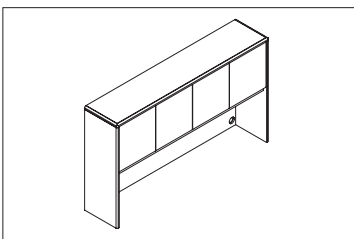

### Credenza Hutch

Item	W	D	H	Weight lbs.	Cubic Ft.	Cartons	List Price
RO300	72	15	42	165	29.50	1	\$1,608
RO320	66	15	42	155	28.30	1	\$1,554

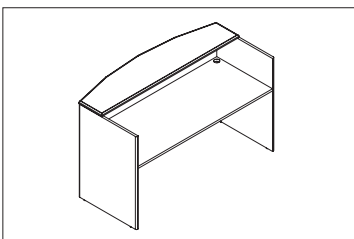

### Reception Desk Shell

Item	W	D	H	Weight lbs.	Cubic Ft.	Cartons	List Price
RO240	72	36	43	248	9.50	1	\$1,838

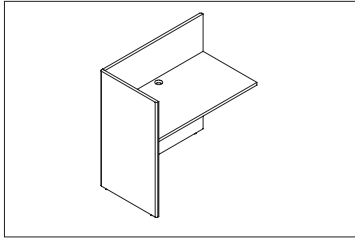

### Reception Return

Item	W	D	H	Weight lbs.	Cubic Ft.	Cartons	List Price
RO249	42	20	43	95	4.00	1	\$759

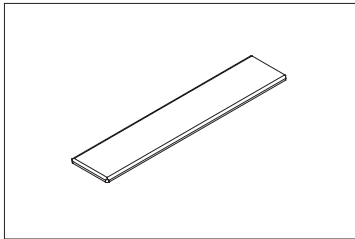

### Tackboard

Item	W	D	H	Weight lbs.	Cubic Ft.	Cartons	List Price
RO3001	69	1.5	19.5	10	1.20	1	\$208

For Hutch RO300

RO3201	63	1.5	19.5	9.5	1.10	1	\$191
--------	----	-----	------	-----	------	---	-------

For Hutch RO320

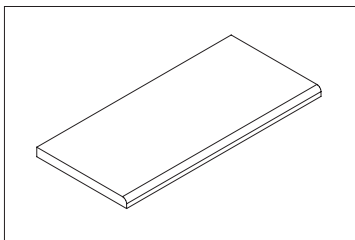

### Wood Keyboard Slide

Item	W	D	H	Weight lbs.	Cubic Ft.	Cartons	List Price
RO120	22	12	1	12	1.00	1	\$105

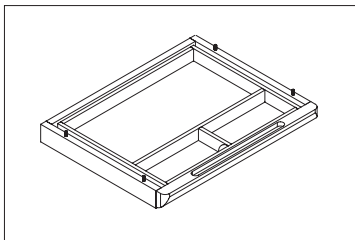

### Center Drawer

Item	W	D	H	Weight lbs.	Cubic Ft.	Cartons	List Price
RO130	20	14	1	8	0.60	1	\$85

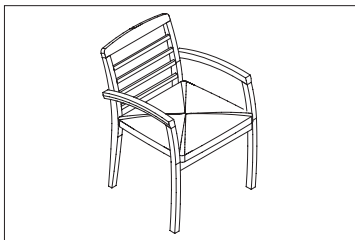

### Guest Chair

Item	W	D	H	Weight lbs.	Cubic Ft.	Cartons	List Price
Chair01	23	23	32.5	21	5.10	4pcs	\$450

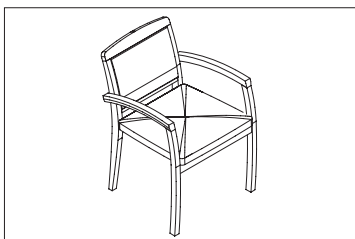

### Guest Chair

Item	W	D	H	Weight lbs.	Cubic Ft.	Cartons	List Price
Chair02	23	23	32.5	21	5.10	4pcs	\$450

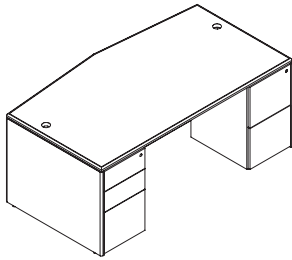

### Bow Desk Shell

Item	W	D	H	Weight lbs.	Cubic Ft.	Cartons	List Price
Layout 1							\$2,819
RO910	72	39	29	180	7.80	1	\$1,398
RO713	15.5	24.5	27.5	71	7.10	1	\$774
RO712	15.5	24.5	27.5	67	7.00	1	\$647

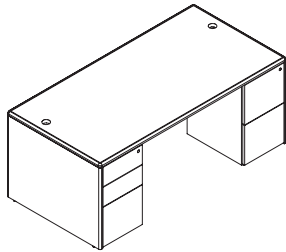

### Desk Shell

Item	W	D	H	Weight lbs.	Cubic Ft.	Cartons	List Price
Layout 2							\$2,756
RO900	72	36	29	175	7.50	1	\$1,335
RO713	15.5	24.5	27.5	71	7.10	1	\$774
RO712	15.5	24.5	27.5	67	7.00	1	\$647

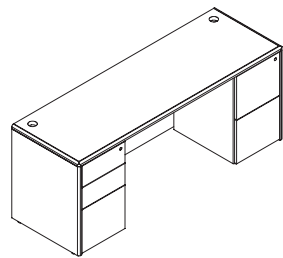

### Credenza Shell

Item	W	D	H	Weight lbs.	Cubic Ft.	Cartons	List Price
Layout 3							\$2,367
RO930	72	20	29	114	5.80	1	\$946
RO713	15.5	24.5	27.5	71	7.10	1	\$774
RO712	15.5	24.5	27.5	67	7.00	1	\$647

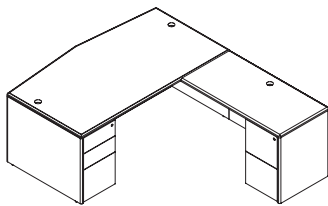

### L.Bow Desk Shell

Item	W	D	H	Weight lbs.	Cubic Ft.	Cartons	List Price
Layout 4							\$3,496
RO910	72	39	29	180	7.80	1	\$1,398
RO967	48	24	29	81	3.90	1	\$677
RO713	15.5	24.5	27.5	71	7.10	1	\$774
RO712	15.5	24.5	27.5	67	7.00	1	\$647

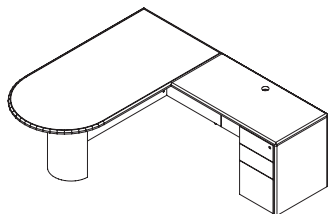

### L.Bullet Desk Shell

Item	W	D	H	Weight lbs.	Cubic Ft.	Cartons	List Price
Layout 7							\$2,864
RO920	72	36	29	134	8.10	2	\$1,413
RO967	48	24	29	81	3.90	1	\$677
RO713	15.5	24.5	27.5	71	7.10	1	\$774

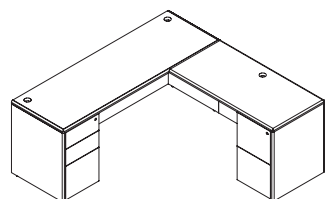

### L.Desk Shell

Item	W	D	H	Weight lbs.	Cubic Ft.	Cartons	List Price
Layout 8							\$3,218
RO902	66	30	29	143	5.30	1	\$1,120
RO967	48	24	29	81	3.90	1	\$677
RO713	15.5	24.5	27.5	71	7.10	1	\$774
RO712	15.5	24.5	27.5	67	7.00	1	\$647

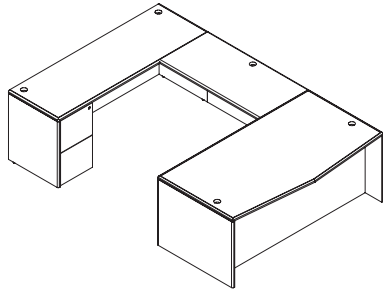

### U.Bow Desk Shell

Item	W	D	H	Weight lbs.	Cubic Ft.	Cartons	List Price
Layout 11							\$4,317
RO910	72	39	29	180	7.80	1	\$1,398
RO957	48	24	29	66	3.00	1	\$552
RO930	72	20	29	114	5.80	1	\$946
RO713	15.5	24.5	27.5	71	7.10	1	\$774
RO712	15.5	24.5	27.5	67	7.00	1	\$647

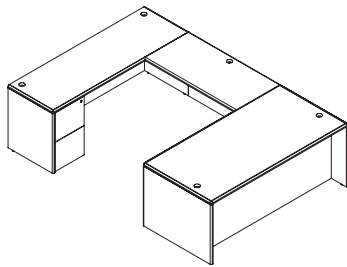

### U.Desk Shell

Item	W	D	H	Weight lbs.	Cubic Ft.	Cartons	List Price
Layout 12							\$4,254
RO900	72	36	29	175	7.50	1	\$1,335
RO957	48	24	29	66	3.00	1	\$552
RO930	72	20	29	114	5.80	1	\$946
RO713	15.5	24.5	27.5	71	7.10	1	\$774
RO712	15.5	24.5	27.5	67	7.00	1	\$647

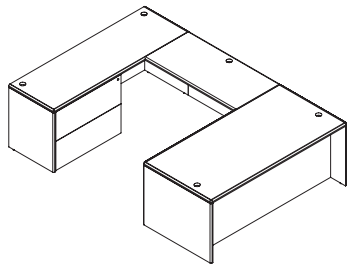

### U.Desk Shell

Item	W	D	H	Weight lbs.	Cubic Ft.	Cartons	List Price
Layout 13							\$4,698
RO900	72	36	29	175	7.50	1	\$1,335
RO957	48	24	29	66	3.00	1	\$552
RO930	72	20	29	114	5.80	1	\$946
RO713	15.5	24.5	27.5	71	7.10	1	\$774
RO752	35	18.5	27.5	94	12.80	1	\$1,091

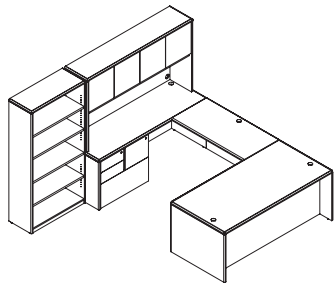

### U.Desk w/Bookcase

Item	W	D	H	Weight lbs.	Cubic Ft.	Cartons	List Price
Layout 21							\$7,632
RO900	72	36	29	175	7.50	1	\$1,335
RO957	48	24	29	66	3.00	1	\$552
RO930	72	20	29	114	5.80	1	\$946
RO734	30	18.5	27.5	115	12.20	1	\$1,865
RO300	72	15	42	165	29.50	1	\$1,608
RO521	36	14	70	153	7.50	1	\$1,326

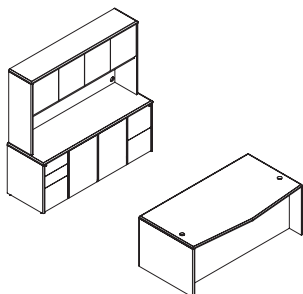

### Bow Desk Shell w/Hutch

Item	W	D	H	Weight lbs.	Cubic Ft.	Cartons	List Price
Layout 22							\$7,062
RO910	72	39	29	180	7.80	1	\$1,398
RO713	15.5	24.5	27.5	71	7.10	1	\$774
RO712	15.5	24.5	27.5	67	7.00	1	\$647
RO740	72	20	29	240	29.50	1	\$2,635
RO300	72	15	42	165	29.50	1	\$1,608

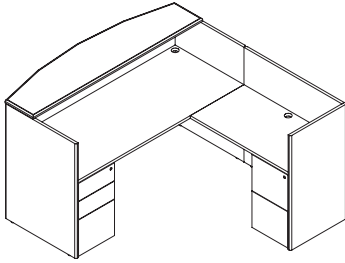

**Reception**

Item	W	D	H	Weight lbs.	Cubic Ft.	Cartons	List Price
Layout 24							\$4,018
RO240	72	36	43	248	9.50	1	\$1,838
RO249	42	20	43	95	4.00	1	\$759
RO713	15.5	24.5	27.5	71	7.10	1	\$774
RO712	15.5	24.5	27.5	67	7.00	1	\$647